



CAT Retro Control Board Installation



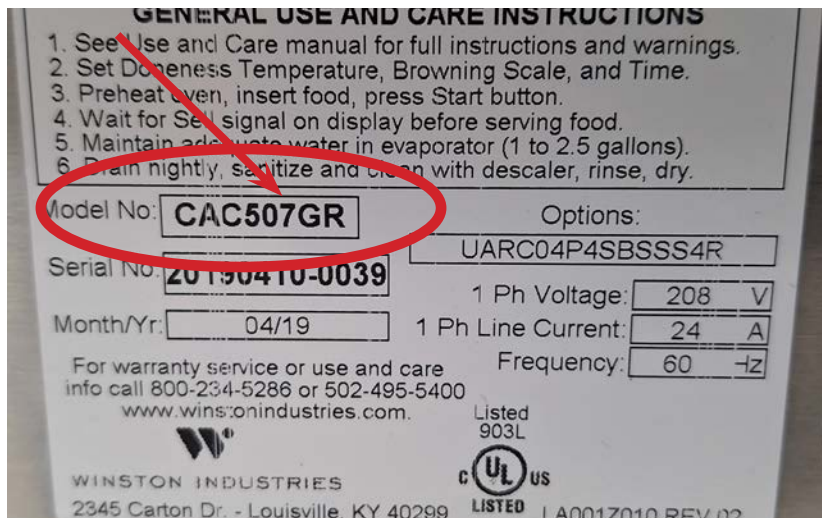
Follow QR Code for Manual
Download, Videos, and More.



CAT Retro Control Board Installation

Tools Required: Phillips Screwdriver Hammer
Flat-tipped Screwdriver Needle-nosed Pliers
3/8" Nut driver 9/16" Wrench
3/8" Wrench SV1206Kit

This instruction guide covers the retro control board installation for CAT series CVaps. Refer to the serial tag for model information.



Do not plug the new control board into the unit until the new relay panel is installed. The new control board runs on 24V and the line voltage will cause damage to new control board.

****The air probe, water probe, and float must be replaced. The new control board will not operate correctly with the old probes and float.**

****The existing relays must be replaced.****

CAT Retro Control Board Installation

1. Power the unit off and disconnect from power source. (Fig.1-2)



Fig.1



Fig.2

Air Probe Replacement

2. Locate the air probe access panel on the right side of the cabinet. Using a Phillips screwdriver, remove the panel. (Fig.3-4)



Fig.3



Fig.4

3. Locate the two pin molex connection and disconnect the two pin connection. (Fig.5-6)



Fig.5



Fig.6

CAT Retro Control Board Installation

4. Pull back the insulation and locate the air probe. Using a 3/8" nut-driver, remove the two retaining nuts. (Fig.7-8)



Fig.7



Fig.8

5. Pull retaining bracket up and off of the mounting studs. Next remove the air probe, back retainer, and orange washer. (Fig.9-10)



Fig.9



Fig.10

6. Locate the replacement air probe in the kit. Thread the mounting bracket, followed by the back bracket, and finally the orange washer. (Fig.11-12)

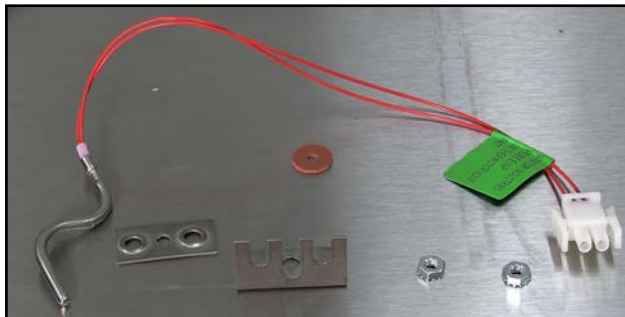


Fig.11



Fig.12

CAT Retro Control Board Installation

7. Insert air probe into opening and rotate until probe tip inside the unit is pointing down. (Fig.13-14)



Fig.13



Fig.14

8. Start the two retaining nuts and tighten them using a 3/8" nut driver or socket. (Fig.15-16)

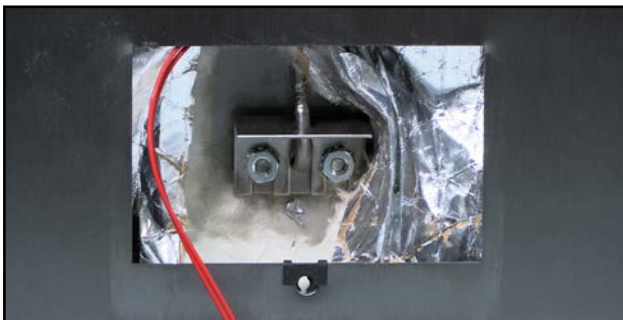


Fig.15



Fig.16

9. Reconnect the Molex connection and using a Phillips screwdriver or screw gun, replace the access panel. (Fig.17-18)



Fig.17



Fig.18

CAT Retro Control Board Installation

Water Probe Replacement

10. Drain the water from the unit. Using a Phillips screwdriver or screw gun, remove the lower access panel on the right side.(Fig.19-20)



Fig.19



Fig.20

11. Locate the water probe connection. And disconnect the probe wire.(Fig.21-22)



Fig.21



Fig.22

12. Locate the water probe compression nut. Using a 9/16" wrench loosen and remove the water probe compression nut. (Fig.23-24)

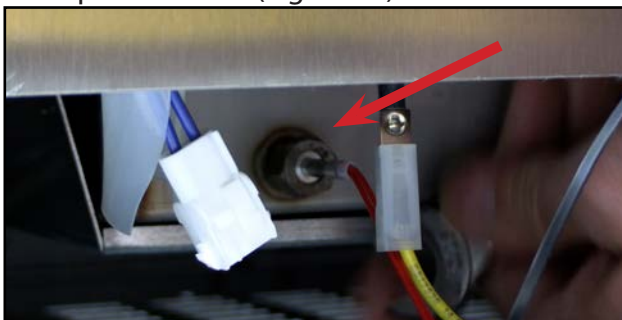


Fig.23

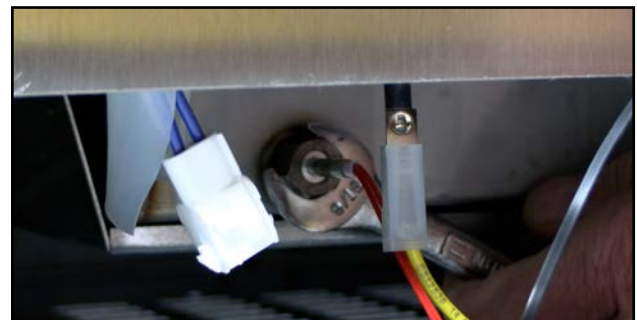


Fig.24

CAT Retro Control Board Installation

13. Gently tap the water probe with a hammer, then ,using pliers pull the water probe out of the water pan. (Fig.25-26)



Fig.25



Fig.26

14. Locate the new water probe in the kit and thread on the compression nut and ferrule. The ferrule needs to be 2-1/4" from the probe tip.(Fig.27-28)



Fig.27

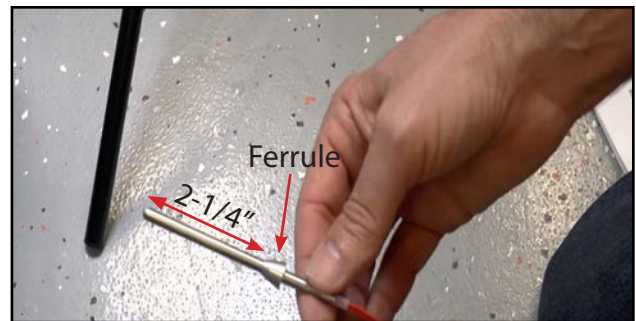


Fig.28

15. Insert the water probe into the probe opening. Thread the compression nut on and tighten the compression nut using a 9/16" wrench. Tighten the compression nut until the probe will no longer slide in or out. Reconnect the two pin molex connection.(Fig.29-30)



Fig.29



Fig.30

CAT Retro Control Board Installation

Float Replacement

16. Locate the red and black float wires near the water probe connection. Disconnect both wires.(Fig.31-32)

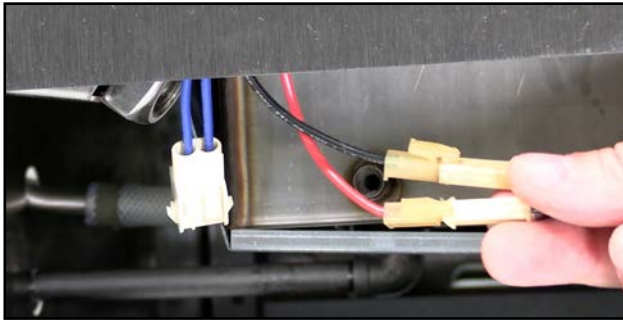


Fig.31

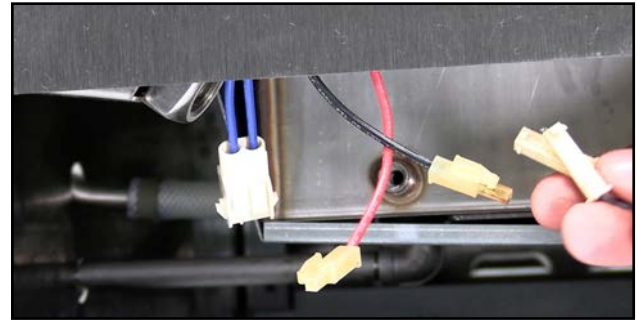


Fig.32

17. Locate the float retaining nut in the center of the evaporator pan. Using an adjustable wrench, loosen the nut. (Fig.33-34)



Fig.33



Fig.34

18. Remove the retaining nut and washer. Pull the float and wires out through the inside of the evaporator pan. (Fig.35-36)



Fig.35



Fig.36

CAT Retro Control Board Installation

19. Locate the seven pieces of the water sensor in the kit. Slide the rubber gasket onto the threaded fitting.(Fig.37-38)



Fig.37



Fig.38

20. Insert water sensor fitting into float opening. Place washer on outside threads. (Fig.39-40)



Fig.39



Fig.40

21. Place sensor nut onto threads and tighten with a 3/4" wrench. A 3/4" wrench will have to be used on the inside as well. (Fig.41-42)



Fig.41



Fig.42

CAT Retro Control Board Installation

22. Insert the water sensor into the fitting. Ensure that there is 1/4" between the sensor and the fitting. (Fig.43-44)



Fig.43



Fig.44

23. Thread the plastic compression nut onto the threaded fitting and tighten until the sensor doesn't slide forwards or backwards.(Fig.45-46)



Fig.45



Fig.46

24. Connect the brown wire in the kit to the water sensor. Connect the brown wire to the existing sensor black wire.(Fig.47-48)



Fig.47



Fig.48

CAT Retro Control Board Installation

Relay Panel Installation

25. Using a Phillips screwdriver or screw gun, remove the six top retaining screws. Remove the unit top.(Fig.49-50)



Fig.49



Fig.50

26. Locate the relay-transformer panel in the kit. The panel will mount in the front right corner. (Fig.51-52)

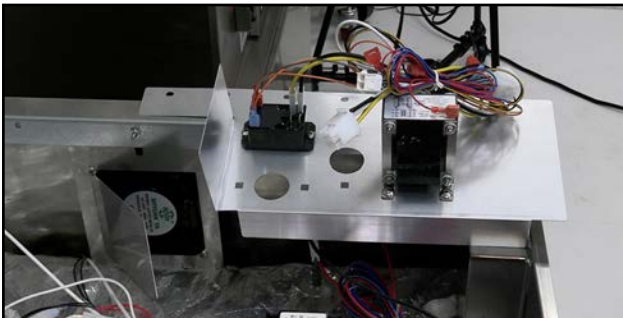


Fig.51



Fig.52

27. Using a 3/8" nut-driver, remove the fan retaining nut. Place the relay panel over the fan screw and reattach the retaining nut. (Fig.53-54)



Fig.53



Fig.54

CAT Retro Control Board Installation

28. Locate the machine screw in the kit and mount the front half of the relay panel with it. (Fig.55-56)



Fig.55



Fig.56

Control Board Wiring

29. Using a Phillips screwdriver or screw gun, remove the control board retaining screws. Pull the control board away from the opening.(Fig.57-58)



Fig.57



Fig.58

30. Disconnect the nine pin and the six pin Molex connections and remove the control board. (Fig.59-60)



Fig.59



Fig.60

CAT Retro Control Board Installation

31. Using a flat tip screwdriver, depress the tabs on the control housing female nine pin Molex connection. Push the connection back into the cabinet top. (Fig.61-62)

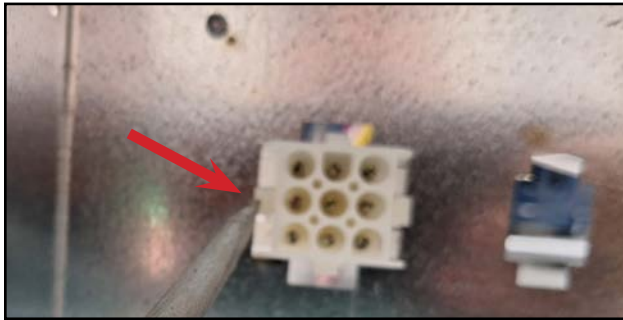


Fig.61

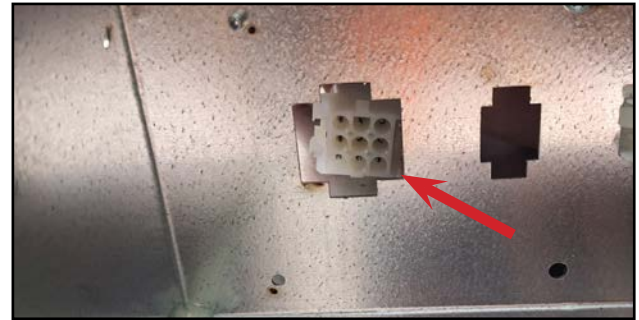


Fig.62

32. Locate the male nine pin Molex relay wires (thicker) that are coming from the relay panel. Connect to the female nine pin Molex connection that was pushed in through the housing.(Fig.63-64)

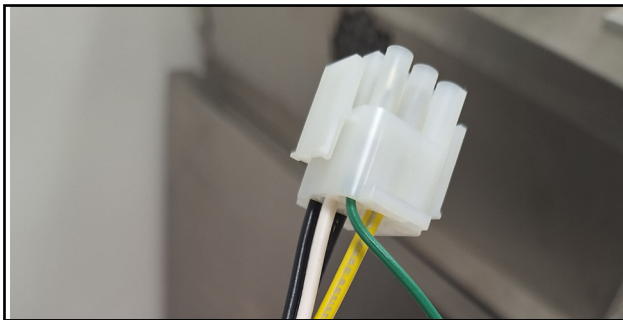


Fig.63

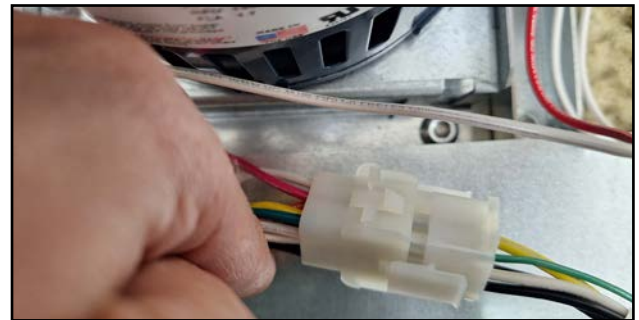


Fig.64

33. Route the signal wire nine pin Molex connection(thinner wires), from the relay panel to the opening where the female wires were pushed through and insert into the opening.(Fig.65-66)

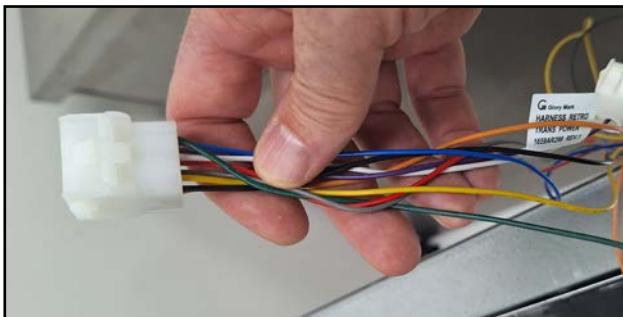


Fig.65

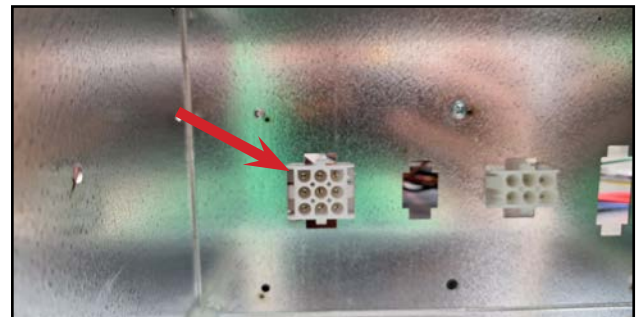


Fig.66

CAT Retro Control Board Installation

34. Locate the green wire connections coming from the signal wire nine pin and locate the green wire connection coming from the thicker nine pin. Connect the two grounding wires.(Fig.67-68)

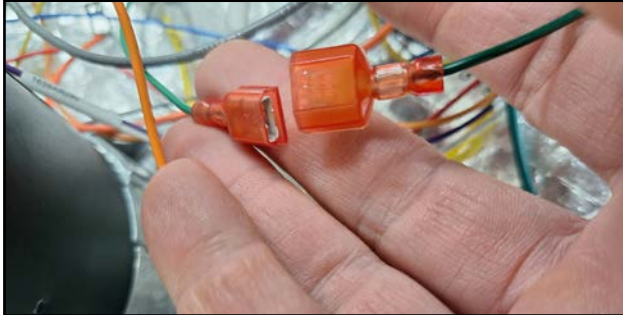


Fig.67

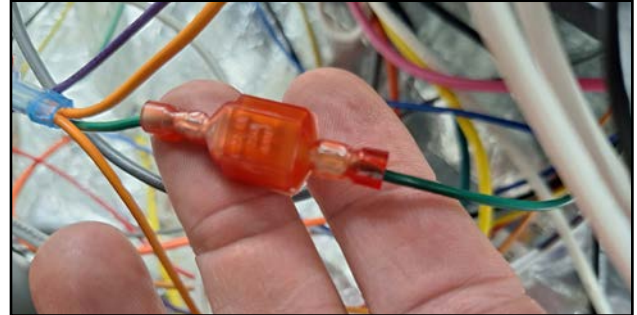


Fig.68

Relay Replacement

1. The four existing relays must be swapped out with the 24V relays in the kits.
****The existing relays will not operate with the new control board.**** (Fig.69)

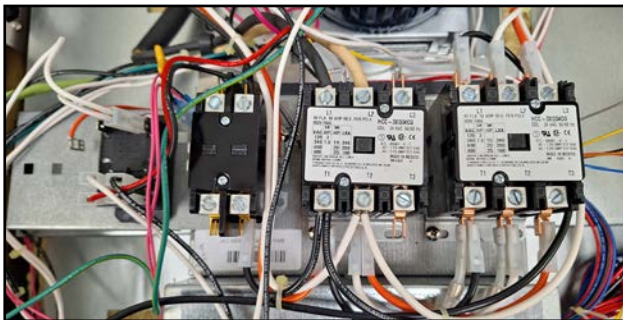


Fig.69

2. Starting with the air heater relay(Right side 3-pole). Remove the two black wires on T1 and the two white wires on T2. Next, remove the orange wire on T3.(Fig.70-71)

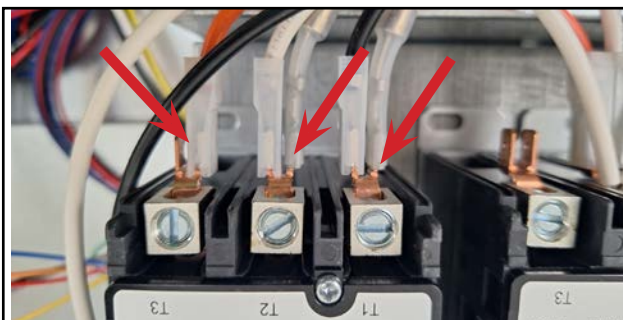


Fig.70

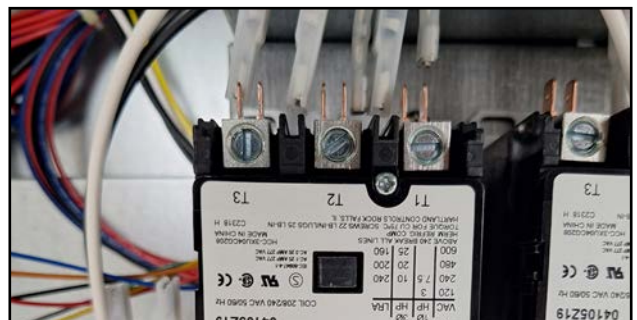


Fig.71

CAT Retro Control Board Installation

- Remove the black wire from L1, the white wire from L2, and the orange wire from L3. Next, remove the white and yellow relay coil wires.(Fig.72-73)

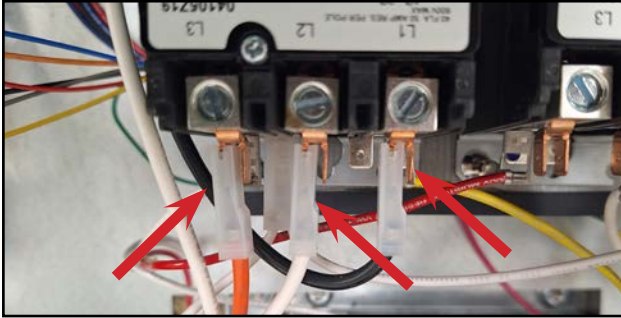


Fig.72

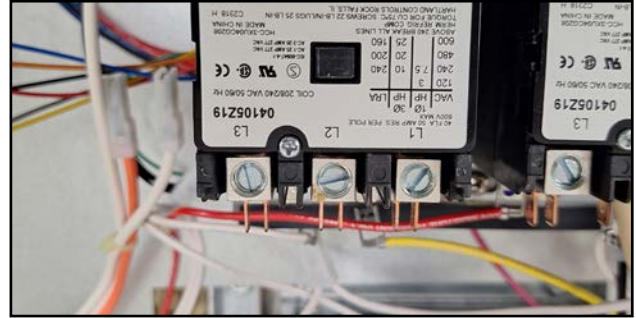


Fig.73

- Using a Phillips screwdriver, remove the two relay retaining screws. Then remove the relay. (Fig.74-75)



Fig.74



Fig.75

- Locate one of the 3-pole 24V relays in the kit. Using a Phillips screwdriver, mount the relay in the place of the removed air relay. (Fig. 76-77)



Fig.76

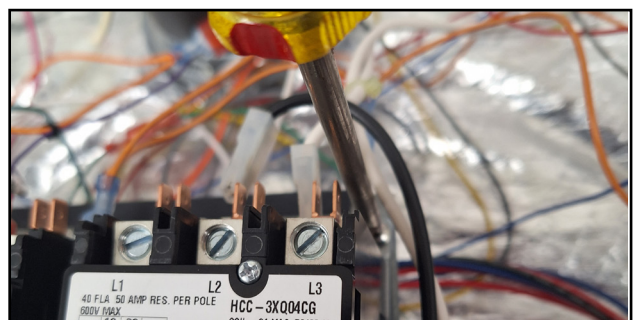


Fig.77

CAT Retro Control Board Installation

6. Locate the set of orange wire connections coming from the new relay panel. Connect the first connector (closest to relay panel) to the air relay coil. (In place of white coil wire). Locate the red wire connection coming from signal wire moxex connection. Plug the red connection into the left side coil connection on the air relay. (In place of the yellow coil connection) (Fig. 78-79)

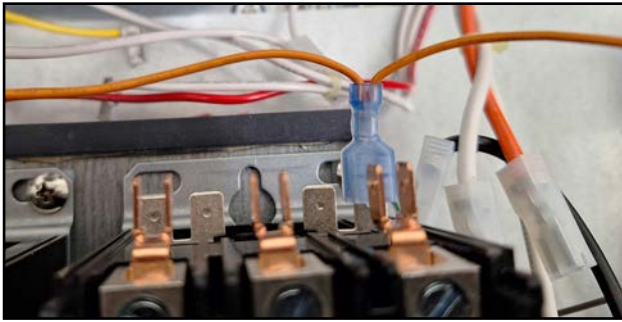


Fig.78

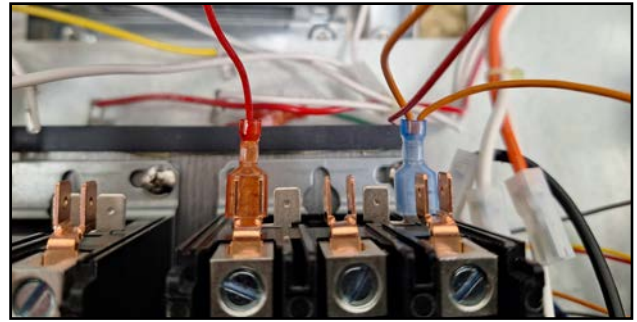


Fig.79

7. Reconnect the black wire to L1, the white wire to L2, and the orange wire to L3. (Fig.80-81)

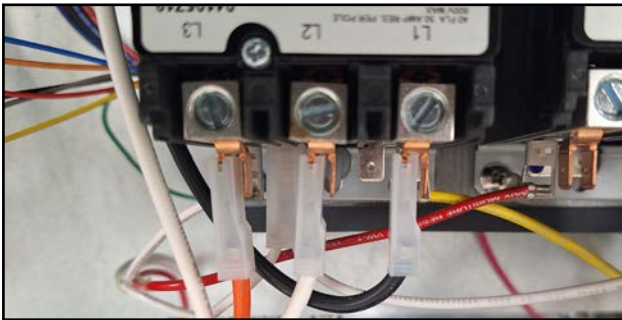


Fig.80

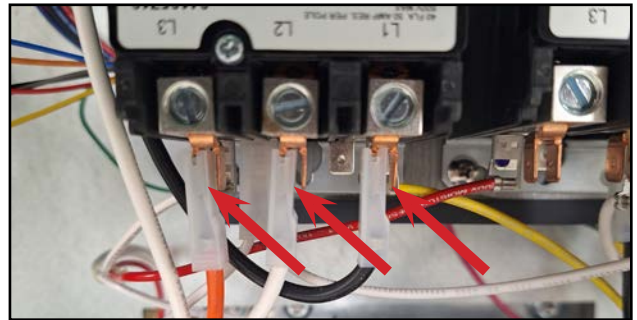


Fig.81

8. Reconnect the two black wires to T1, and the two white wires to T2. (Fig.82-83)



Fig.82

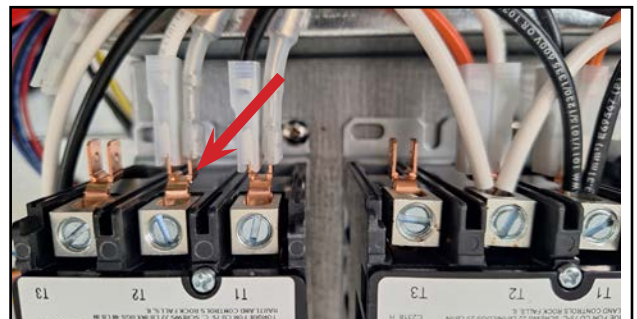


Fig.83

CAT Retro Control Board Installation

9. Reconnect the orange wire to T3.(Fig.84)

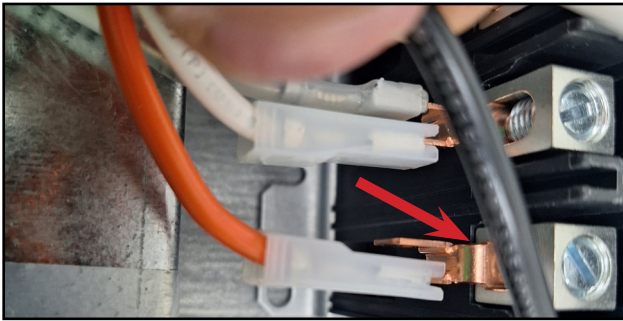


Fig.84

10. Using a flat tip screwdriver, remove the two white wires from the T2 connection on the middle (main power) relay. Then remove the two black wires on the T1 connection.(Fig.85-86)

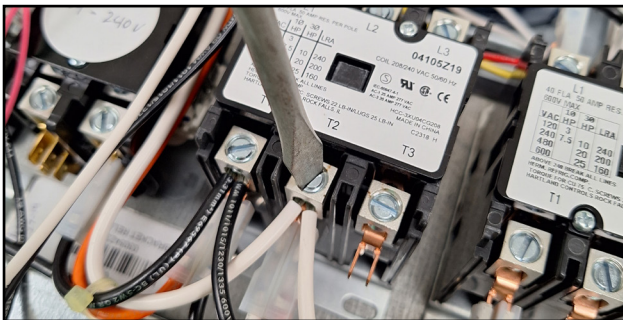


Fig.85

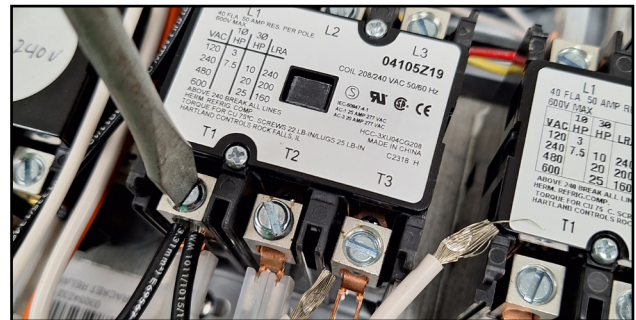


Fig.86

11. Remove the orange and white wires below T2. Next remove the orange and black wires below T1. (Fig.87-88) *** If the unit is 3-phase, there will be two black wires on T1, two white wires on T2, and two orange wires on T3.***

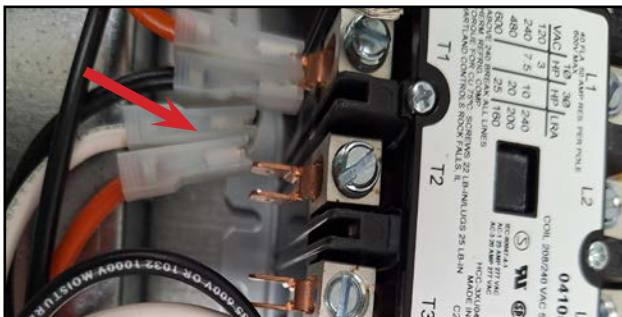


Fig.87

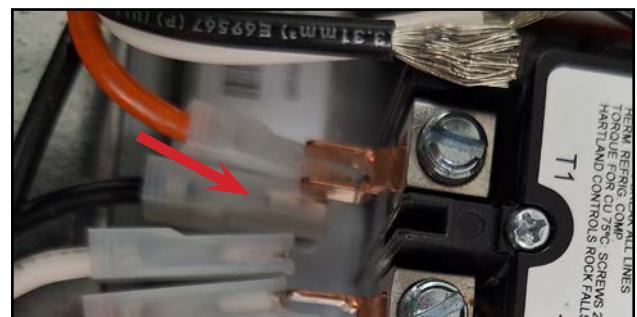


Fig.88

CAT Retro Control Board Installation

12. Using a flat tip screwdriver, remove the white power cord wire from L2 and the black power cord wire from L1. *** If unit is 3-phase, remove red power cord wire from L3.*** (Fig.89-90)



Fig.89

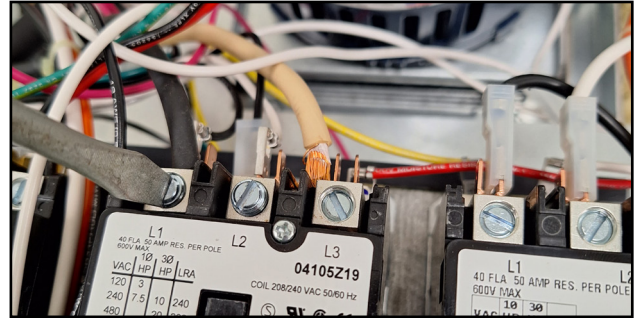


Fig.90

13. Remove the white wire from L2 and the black wire from L1. (Fig.91-92)

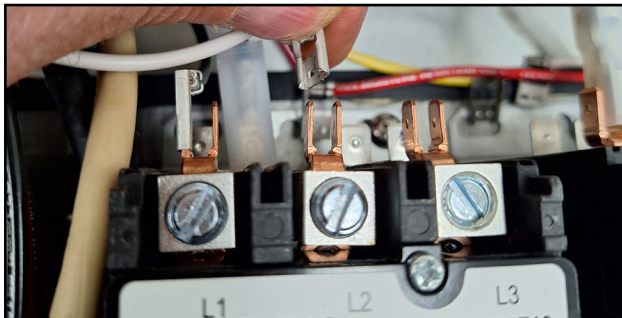


Fig.91

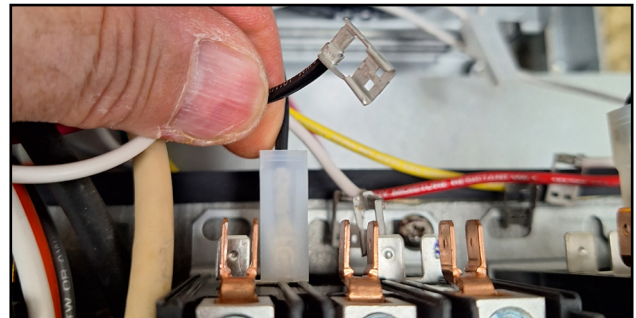


Fig.92

14. Remove the red coil wire and the black coil wire from the main relay.(Fig.93-94)

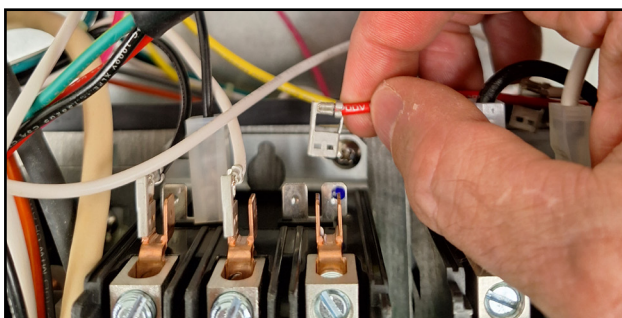


Fig.93

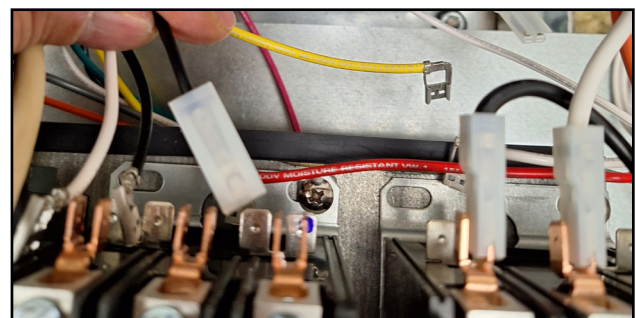


Fig.94

CAT Retro Control Board Installation

15. Using a Phillips screwdriver, remove the two relay retaining screws and then remove the relay.(Fig.95-96)

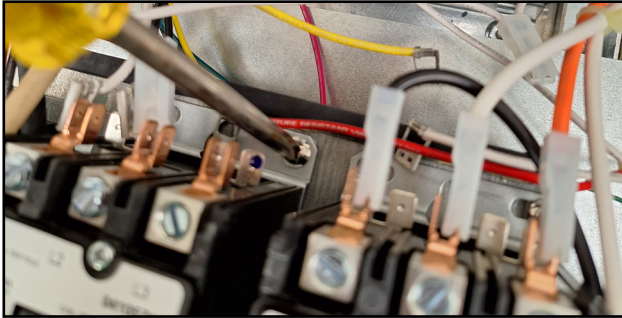


Fig.95

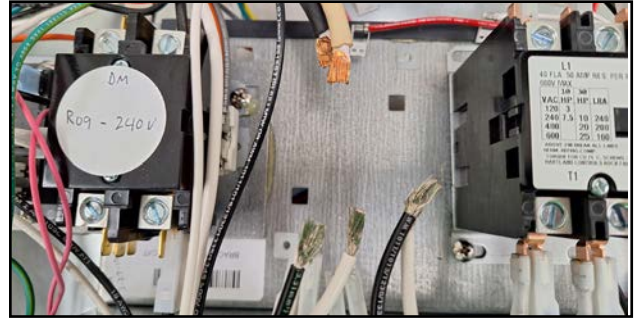


Fig.96

16. Locate the 24v 3-pole relay in the kit and mount using a Phillips screwdriver. (Fig.97-98)



Fig.97

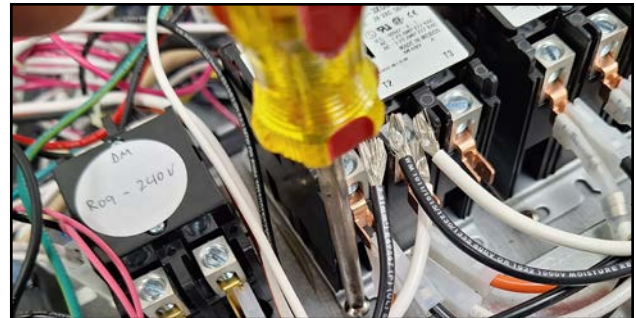


Fig.98

17. Connect the second orange connection coming from the relay panel to the right side coil of the main (middle) relay. Locate the purple, white, and orange wire harness in the kit.(Fig.99-100)

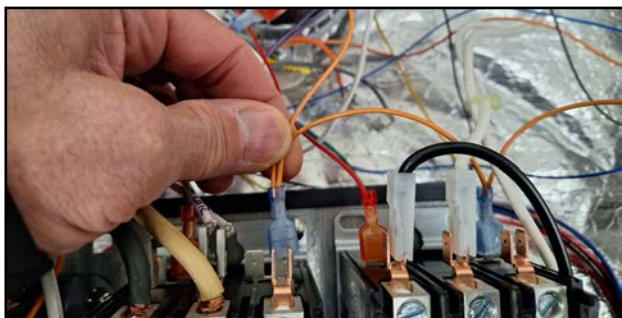


Fig.99

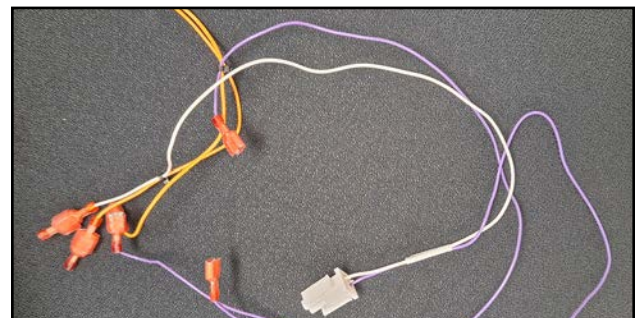


Fig.100

CAT Retro Control Board Installation

18. Connect the purple/white two pin Molex connection on the harness to the purple/white 2-pin Molex coming from the control board Molex. Connect the female orange connection on the harness to the third orange male connection coming from the relay panel. (Fig.101-102)

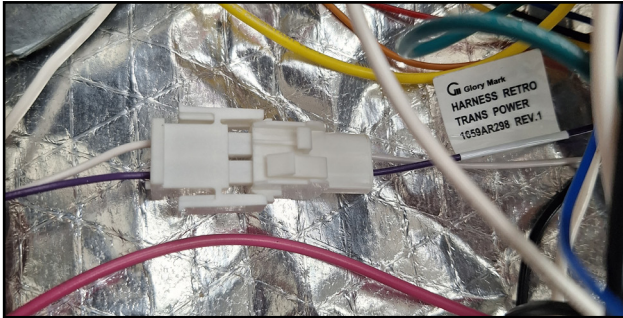


Fig.101



Fig.102

19. Connect the purple female wire ziptied to the orange wires on the harness to the left side coil on the main(middle) relay. (Fig.103)

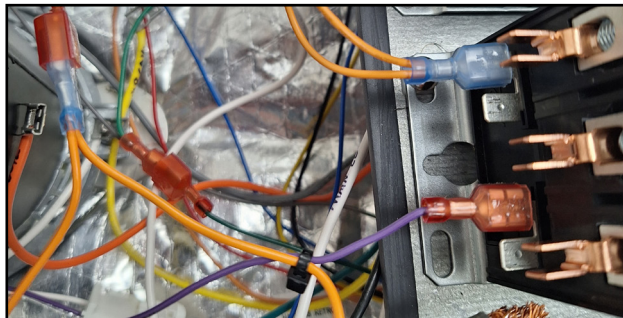


Fig.103

20. Reconnect the white wire on L2 and the black wire on L1. (Fig.104-105)

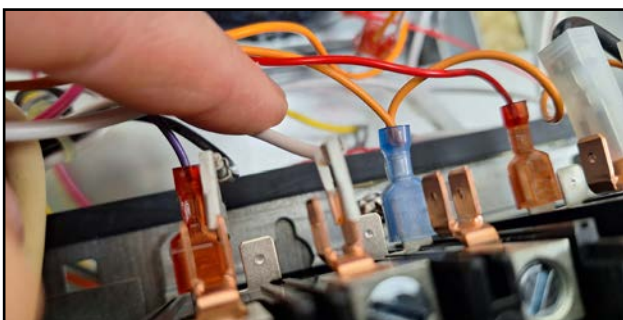


Fig.104

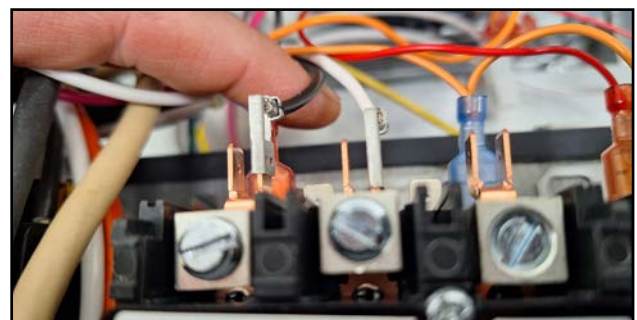


Fig.105

CAT Retro Control Board Installation

21. Using a flat tip screwdriver, connect the black power cord wire to L1 and the white power cord wire to L2. *** If unit is 3 phase, connect the red power cord wire to L3.***(Fig.106-107)

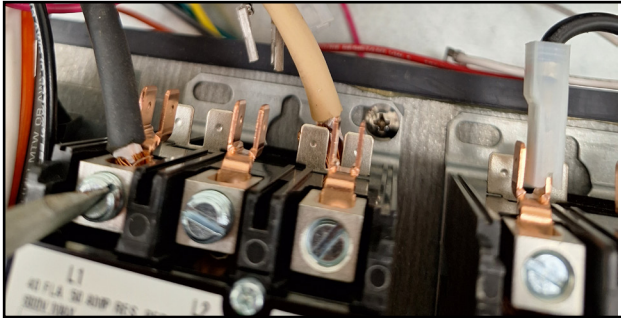


Fig.106

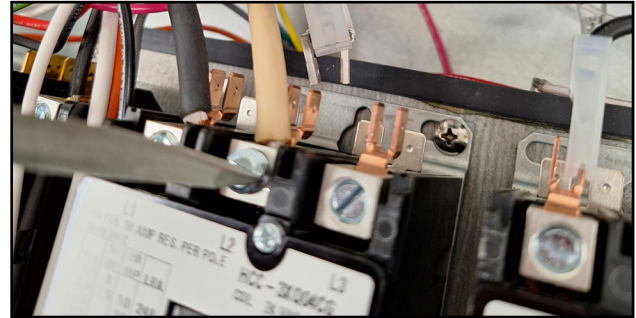


Fig.107

22. Reconnect the orange and black wires to the T1 terminal, and the orange and white wires to the T2 terminal. (Fig.108-109)

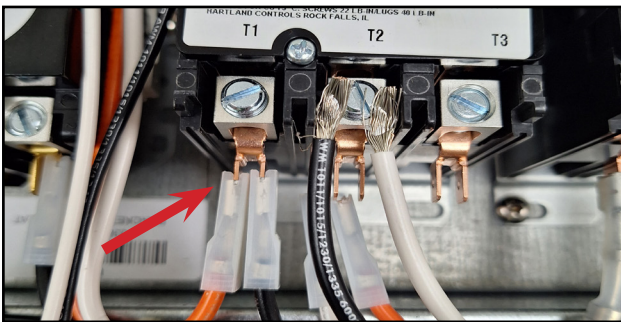


Fig.108

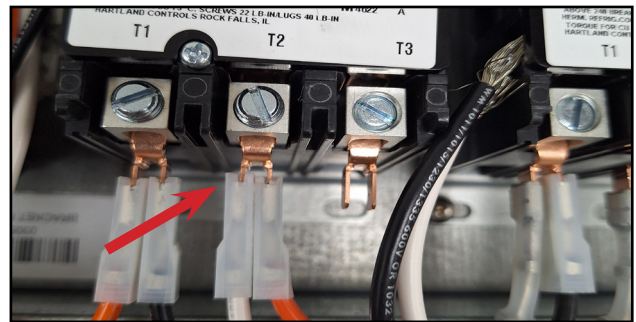


Fig.109

23. Using a flat tip screwdriver, reconnect the two black wires on T1 and the two white wires on T2. (Fig.110-111)

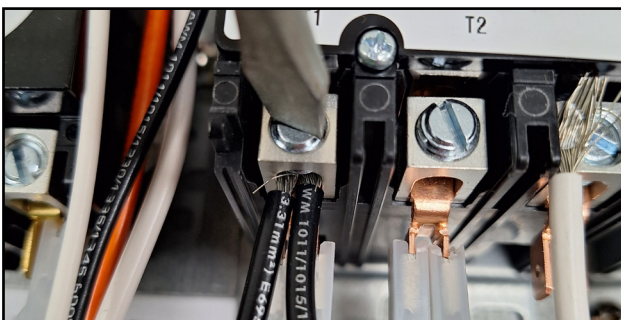


Fig.110

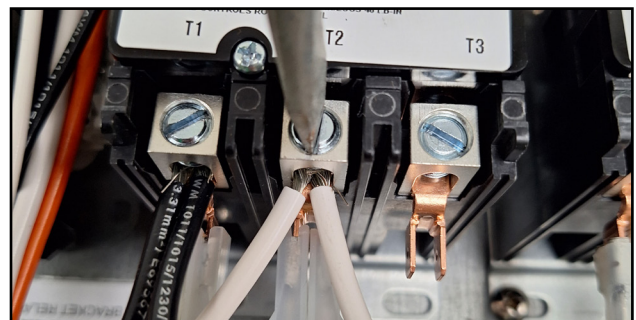


Fig.111

CAT Retro Control Board Installation

24. Locate the 24V two pole relay in the kit. (Fig.112)



Fig.112

25. Remove the black wire from T2 on the existing relay. Using a flat tip screwdriver, remove the black wire from L2 on the existing relay.(Fig.113-114)



Fig.113



Fig.114

26. Remove the grey wire from the right side coil. Remove the double white wire from the left side coil. (Fig.115-116)



Fig.115

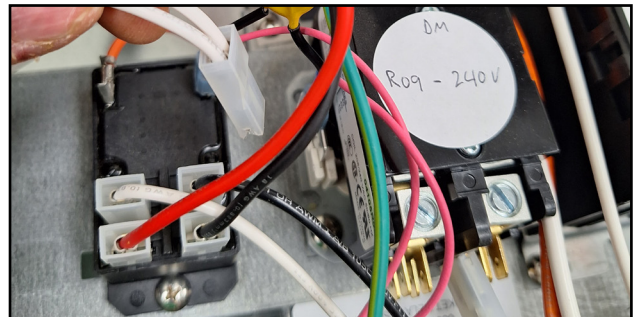


Fig.116

CAT Retro Control Board Installation

27. Remove the black and pink wire from the left side coil wire. (Fig.117)

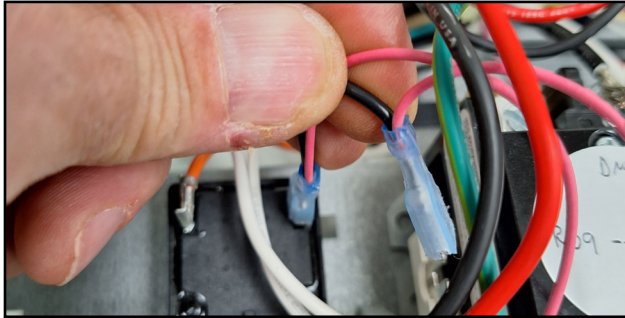


Fig.117

28. Using a Phillips screwdriver, remove the two relay retaining screws. Remove the existing relay.(Fig.118-119)

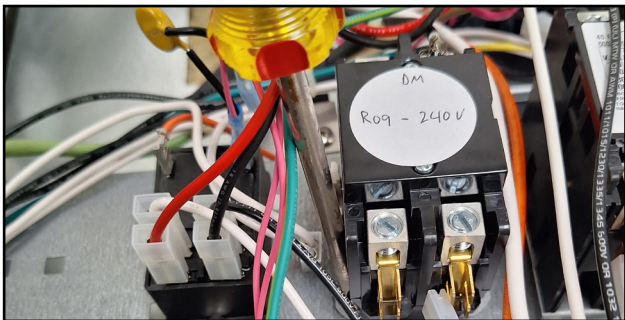


Fig.118

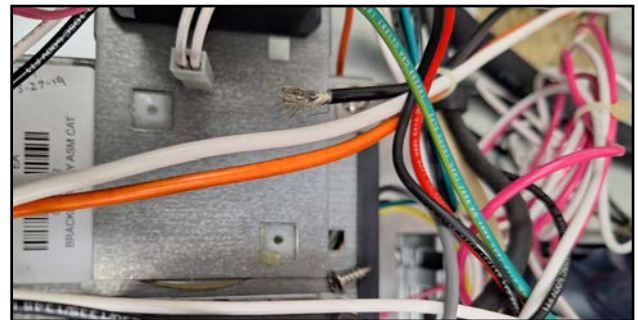


Fig.119

29. Using a Phillips screwdriver, mount the 24V relay with the retaining screws. (Fig.120-121)

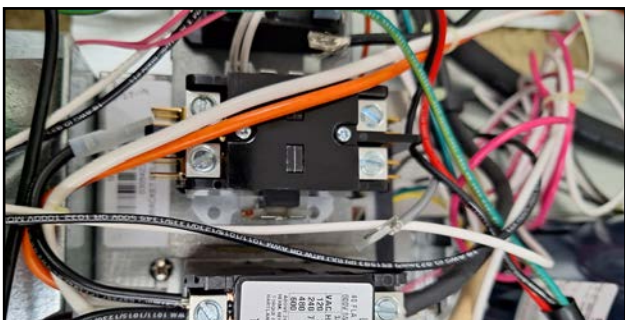


Fig.120

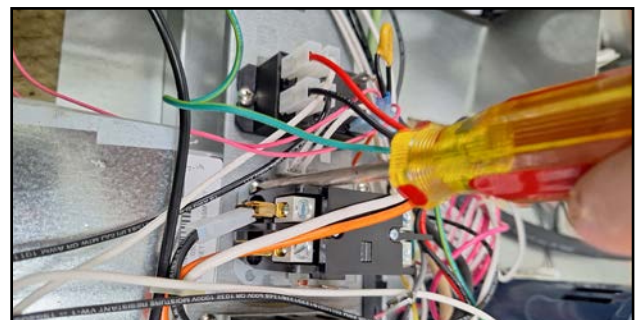


Fig.121

CAT Retro Control Board Installation

- 30 Locate the orange female connection ziptied to the purple wire and connect to the right side coil of the evap relay. Locate the blue female connection coming from the control board 9-pin Molex and connect to the left side coil of evap relay. (Fig.122-123)



Fig.122



Fig.123

- 31 Using a flat tip screwdriver, replace the black wire on L2. Reconnect the white wire onto T2. (Fig.124-125)



Fig.124

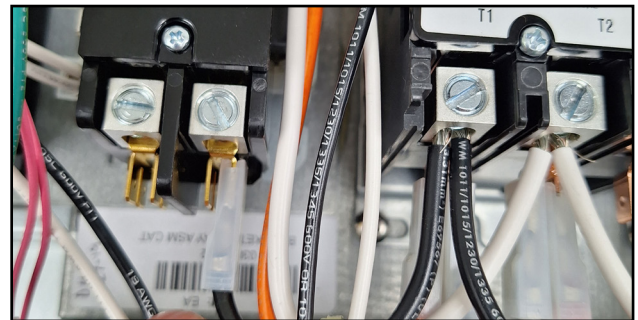


Fig.125

32. Remove the orange wire from the coil of the fan switch relay. Remove the black and pink wire from the fan switch relay coil. (Fig.126-127)

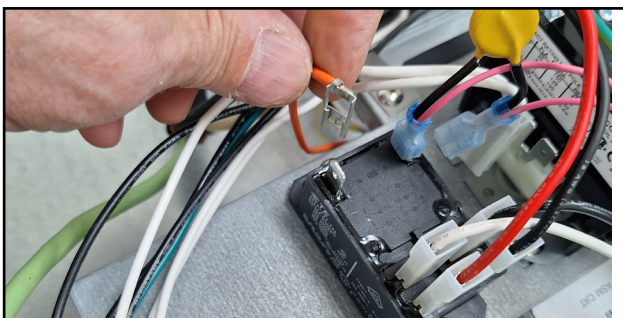


Fig.126

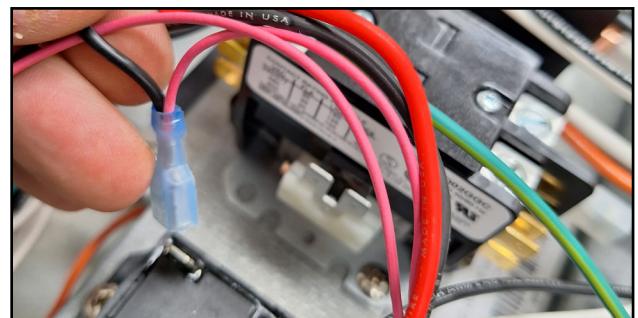


Fig.127

CAT Retro Control Board Installation

33. Remove the red and white wires from the left side of the fan relay. (Fig.128-129)

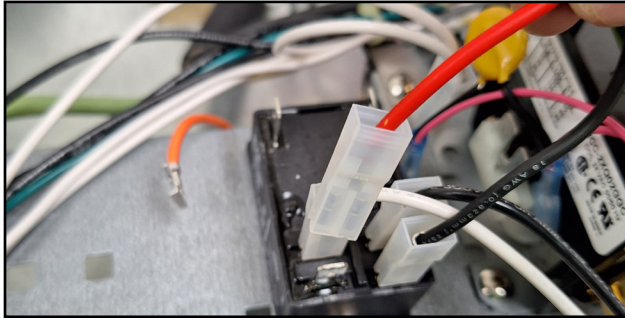


Fig.128

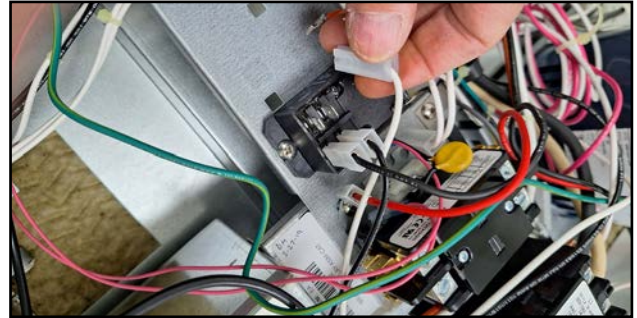


Fig.129

34. Remove the two black wires from the right side of the fan relay. (Fig.130-131)

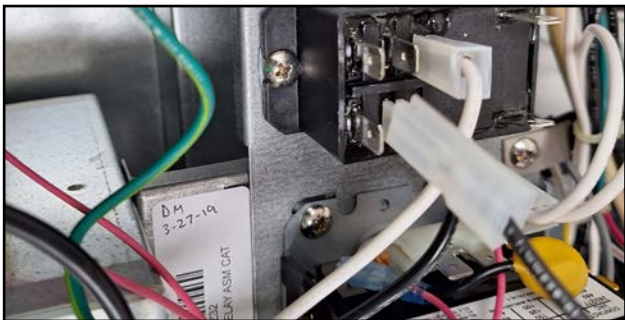


Fig.130

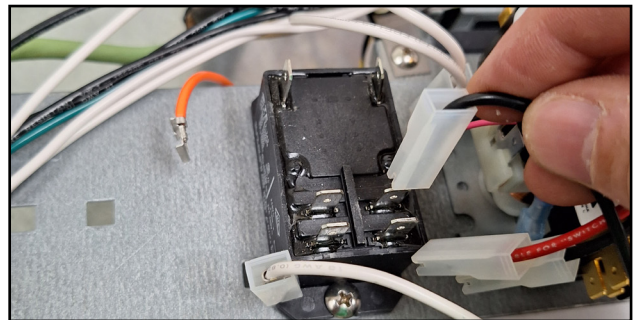


Fig.131

35. Using a Phillips screwdriver, remove the two relay retaining screws and remove the fan relay. (Fig.132-133)

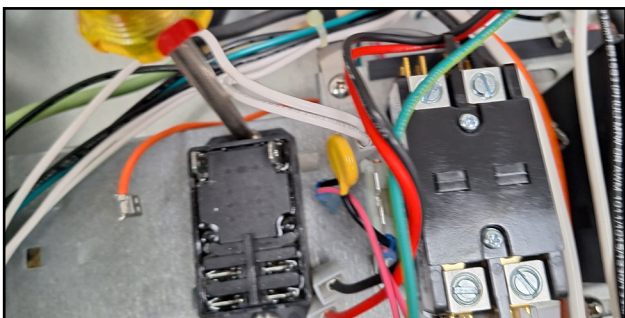


Fig.132

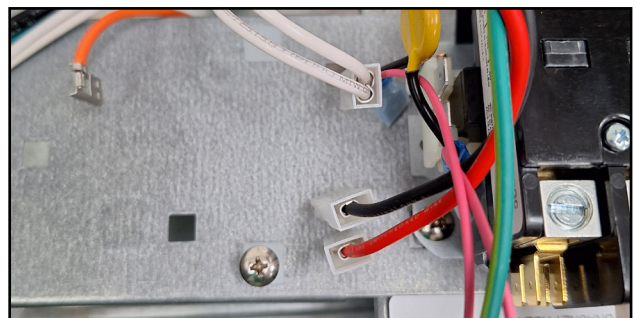


Fig.133

CAT Retro Control Board Installation

36. Locate the 24V fan relay in the kit. Using a Phillips screwdriver, mount the fan relay. (Fig.134-135)



Fig.134

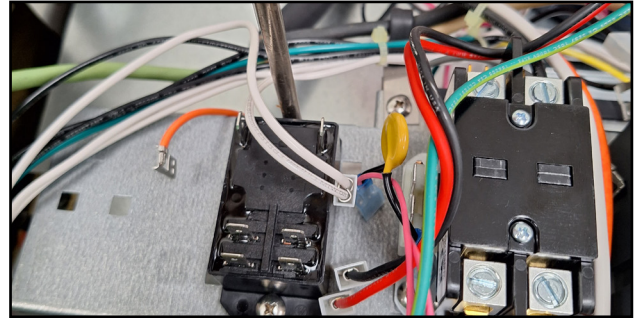


Fig.135

37. Reconnect the red and white wires to the left side of the fan relay. (Fig.136-137)

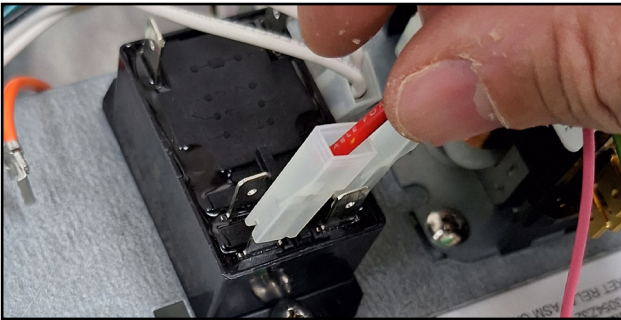


Fig.136



Fig.137

38. Reconnect the two black wires to the right side of the fan relay. (Fig.138-139)



Fig.138

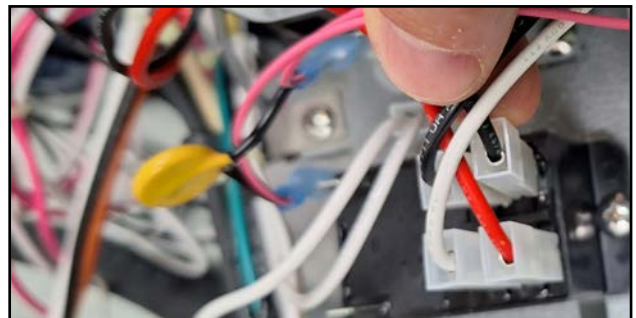


Fig.139

CAT Retro Control Board Installation

39. Locate the capped orange and white wires coming from the new relay panel. Remove the caps.(Fig.140-141)

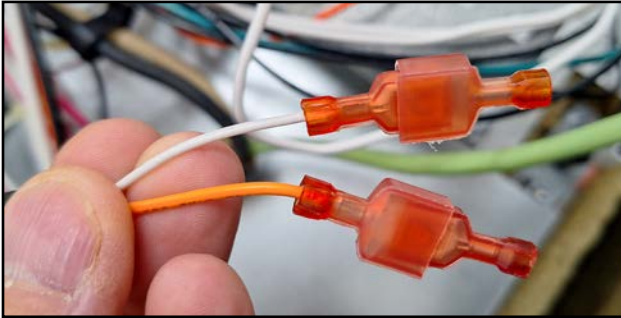


Fig.140

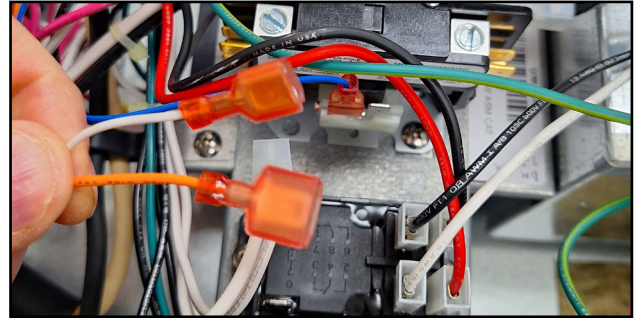


Fig.141

40. Connect the orange wire to the black and pink wire. Connect the black and pink wire to the right side coil of the fan relay. (Fig.142-143)

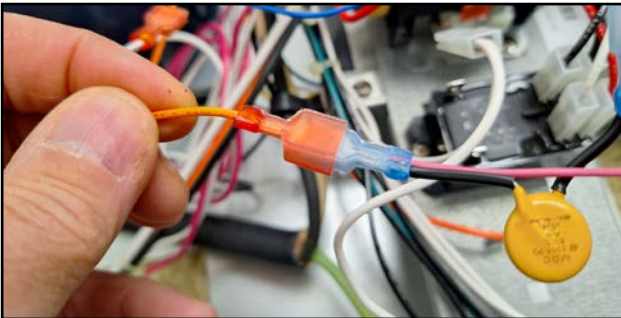


Fig.142

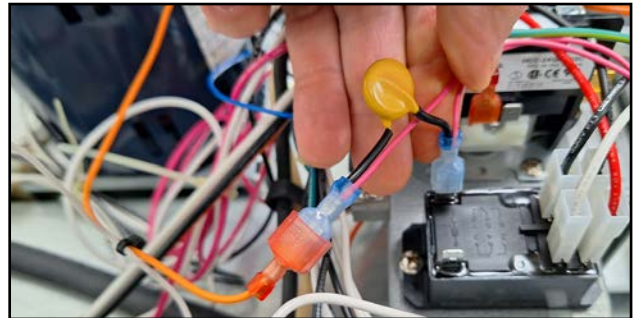


Fig.143

41. Connect the white wire to the left side coil of the fan relay. (Fig.144)

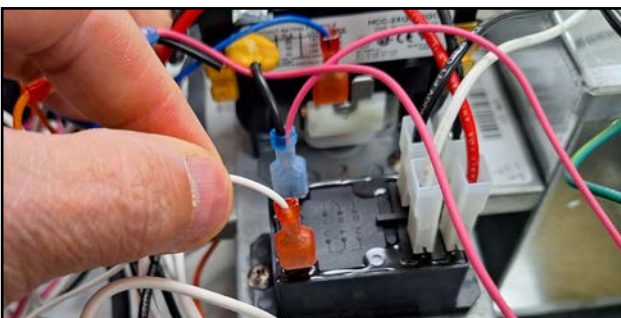


Fig.144

CAT Retro Control Board Installation

42. Locate the high limit (rear right side), and remove the white and red wires.(Fig.145-146)



Fig.145

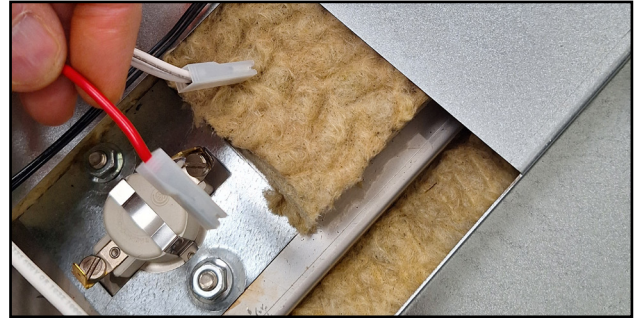


Fig.146

43. Connect the two purple wires to the high limit. (Order doesn't matter) (Fig.147-148)



Fig.147



Fig.148

44. Locate the black wire that was on the coil of the main relay and cap off with provided cap from the kit. (Fig.149-150)

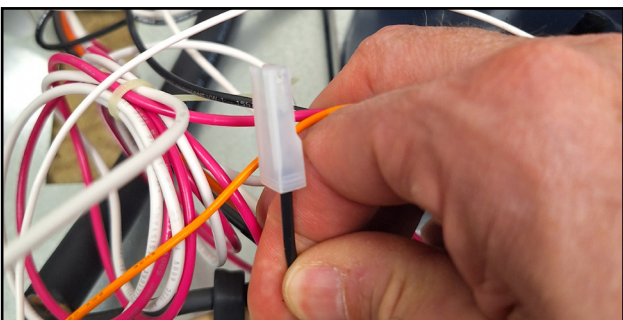


Fig.149

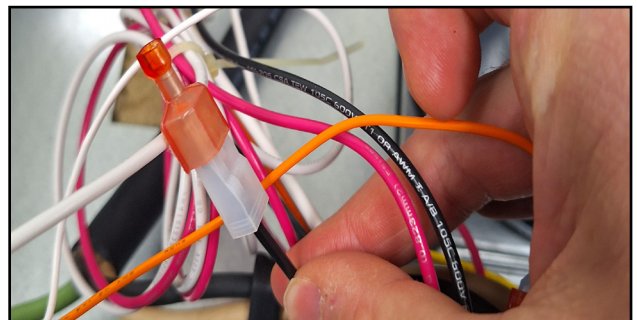


Fig.150

CAT Retro Control Board Installation

45. Locate the double white wire that was connected to the two pole relay, and the capped white wire.(Fig.151-152)

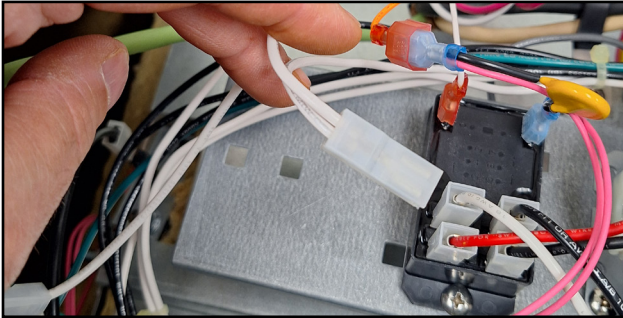


Fig.151

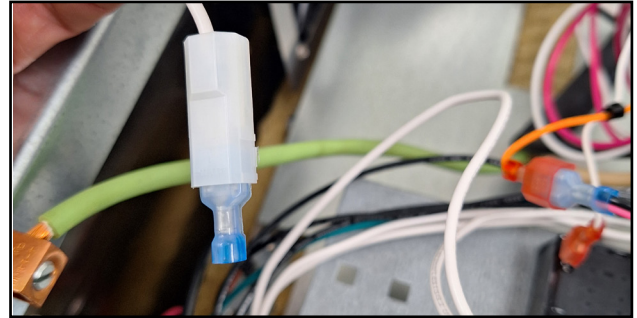


Fig.152

46. Remove the cap from the capped wire and plug the wire into the double white wire. (Fig.153-154)

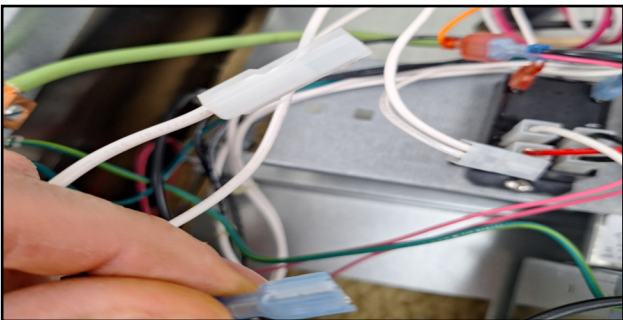


Fig.153

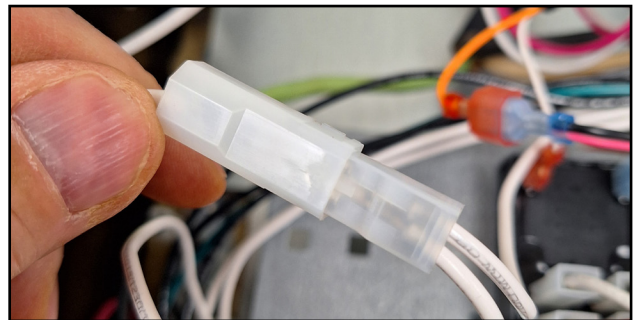


Fig.154

47. Using wire cutters, snip the white wire coming from the double white wire that goes to the high limit. Use the provided wire nut to cap the white wire. (Fig.155-156)

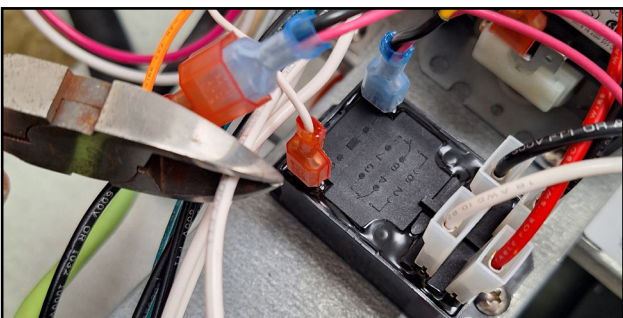


Fig.155

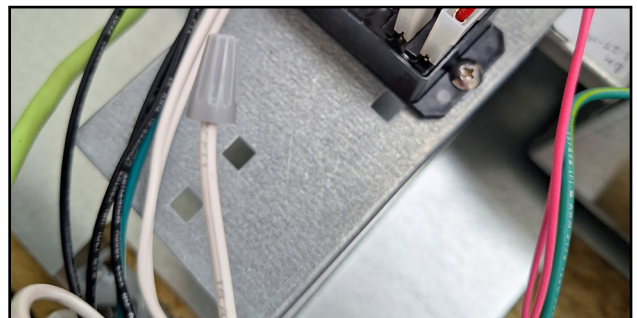


Fig.156

CAT Retro Control Board Installation

48. Remove the red and white high limit wires. Cap the remaining white wire with the provided wire cap.(Fig.157-158)

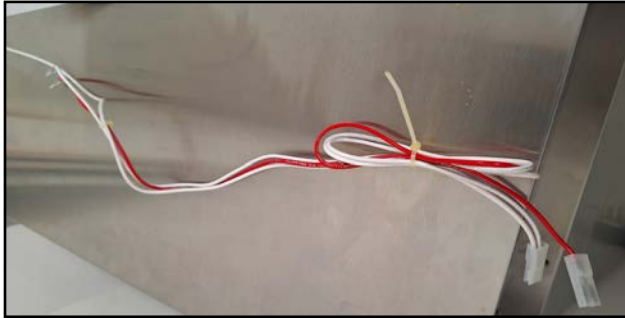


Fig.157

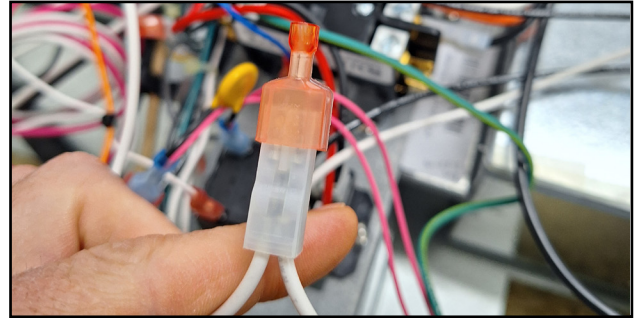


Fig.158

49. Remove the cap from the capped wire and plug the wire into the double white wire, (Fig.153-154)

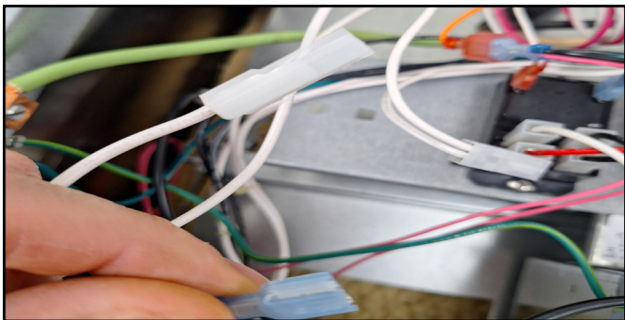


Fig.153

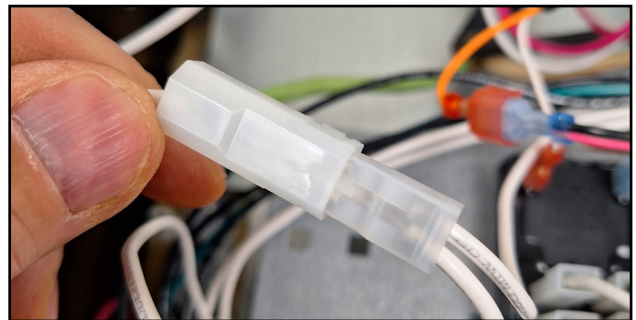


Fig.154

50. Using wire cutters, snip the white wire coming from the double white wire that goes to the high limit. Use the provided wire nut to cap the white wire. (Fig.155-156)

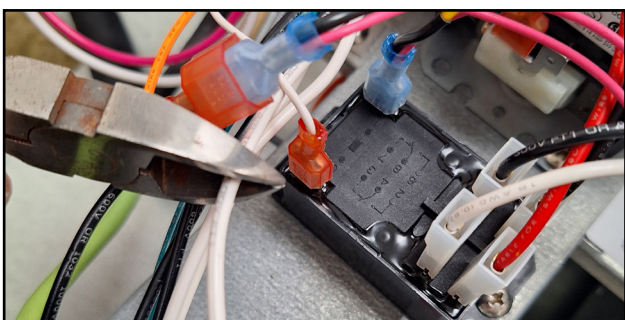


Fig.155

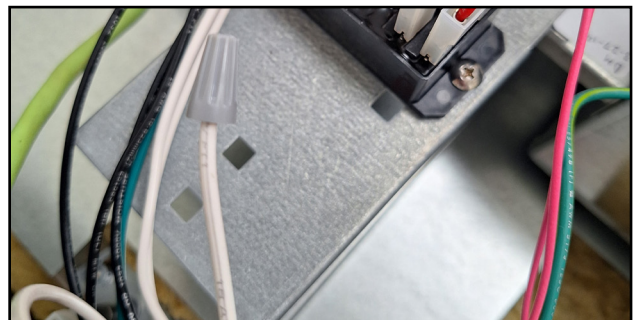


Fig.156

CAT Retro Control Board Installation

51. Locate the unit serial tag and determine the unit voltage. If the unit is 240V, move the black wire on the transformer from the number 4 terminal to the number 6 terminal. (Fig.157-158)

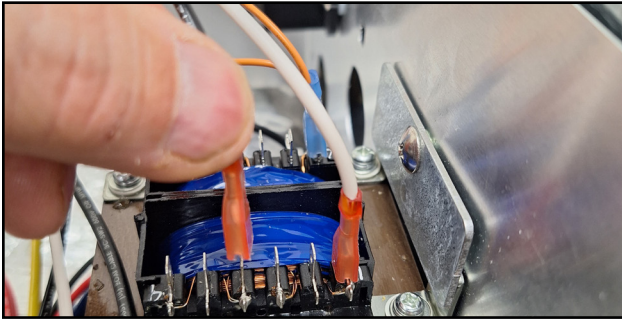


Fig.157

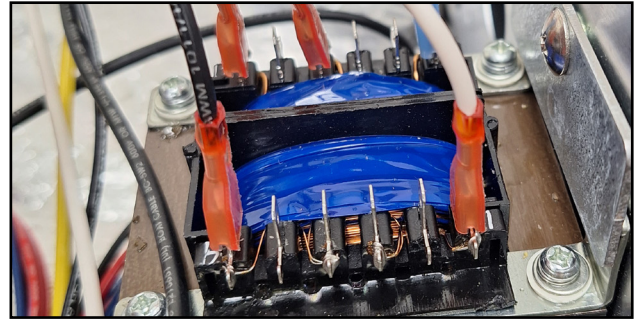


Fig.158

Control Board Mounting

52. Locate the control board adapter in the kit. Using the two existing control board screws, mount the adapter to the unit. (Fig.159-160)



Fig.159

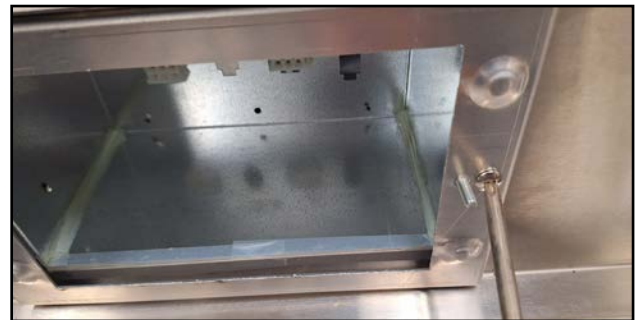


Fig.160

53. Locate the new control board in the kit and plug in the six pin Molex and the nine pin Molex.(Fig.161-162)

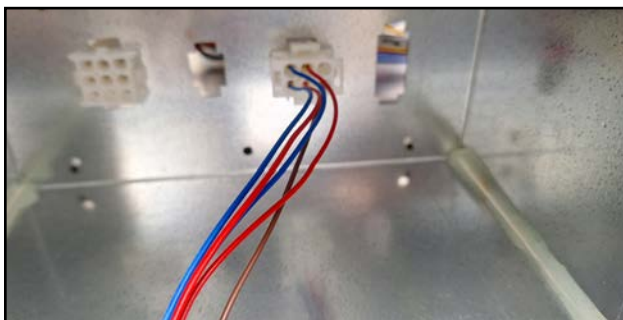


Fig.161

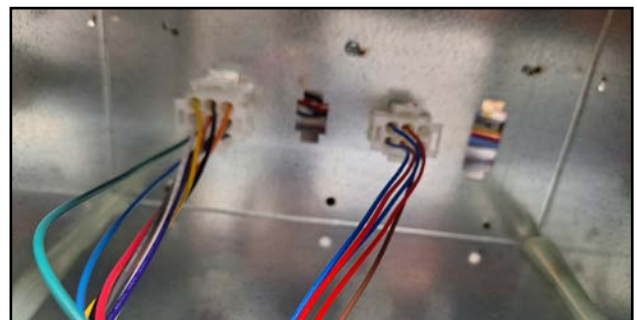


Fig.162

CAT Retro Control Board Installation

54. Slide the new control board onto the mounting studs and using a 3/8" nut driver and the provided acorn nuts, secure the control board.(Fig.163-164)



Fig.163



Fig.164

Final Assembly & Test

55. Replace the unit top and attach with the six existing top screws. (Fig.165-166)



Fig.165



Fig.166

56. Fill the evaporator pan with water and check around the water probe and the water sensor for leaks.(Fig.167-168)



Fig.167



Fig.168

CAT Retro Control Board Installation

57. If no leaks are detected, replace the lower access panel and secure with the four retaining screws. (Fig.169-170)



Fig.169

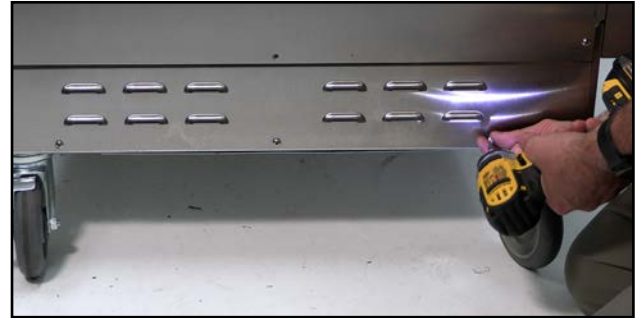


Fig.170

47. Plug the unit in and power the unit on. (Fig.171-172)



Fig.171



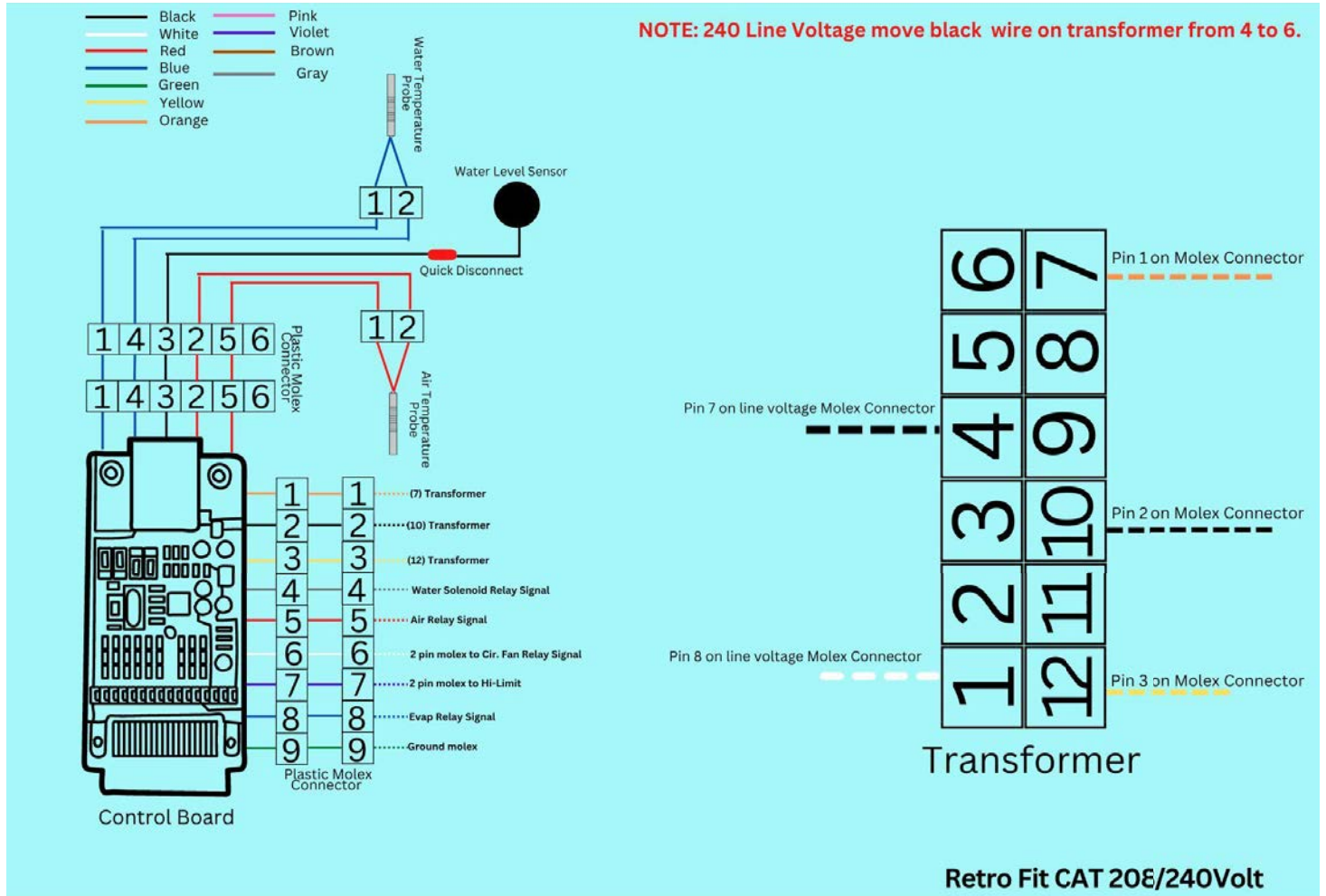
Fig.172

45. Verify that the unit is working correctly and is heating up.(Fig.173)

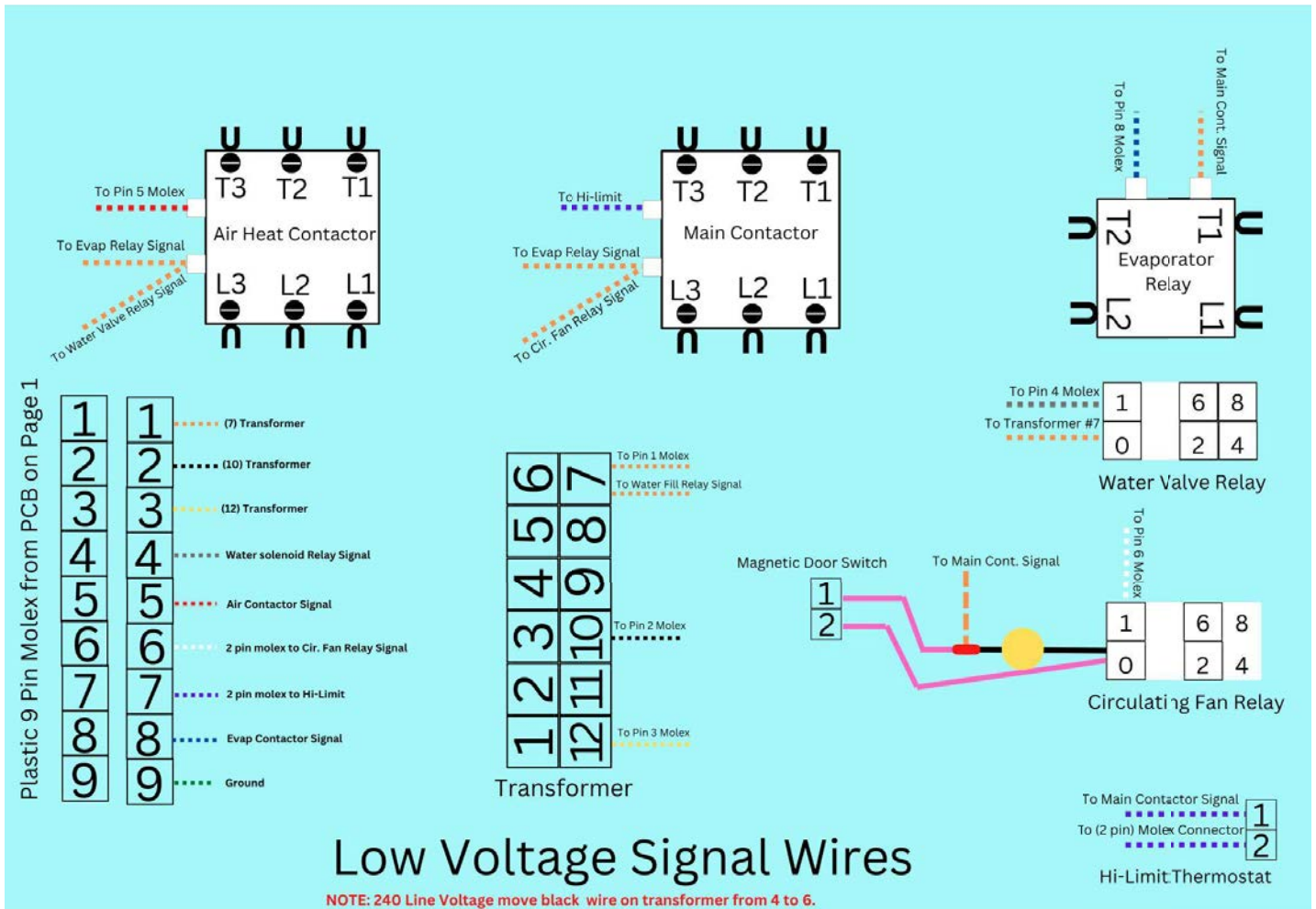


Fig.173

Wiring Diagrams



Wiring Diagrams



Wiring Diagrams

